

STRADA-T-DN

Beam for area lighting with shorter illumination distances optimized for CREE XP-G and XP-E. Assembly with installation tape.

TECHNICAL SPECIFICATIONS:

Dimensions	19.6 x 15.5 mm
Height	8.8 mm
Fastening	tape, pin, screw
Colour	clear
Box size	451 x 273 x 197 mm
Box weight	5.6 kg
Quantity in Box	3360 pcs
ROHS compliant	yes ⓘ

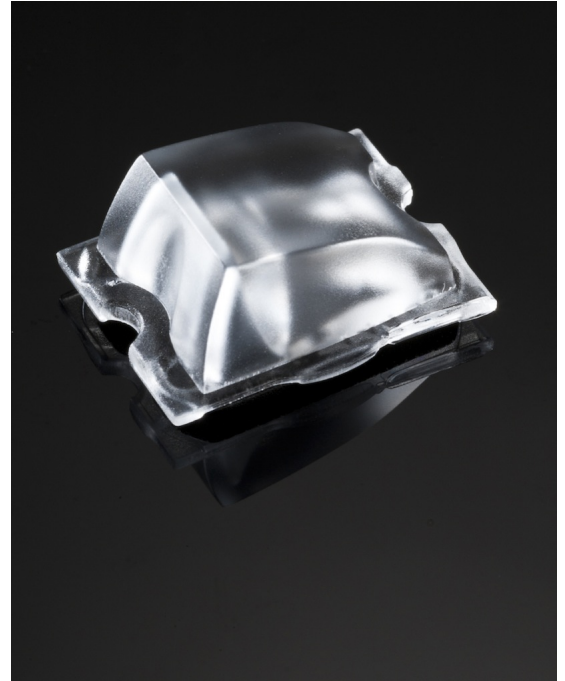

MATERIAL SPECIFICATIONS:

Component	Type	Material	Colour
STRADA-T-DN	Single lens	PMMA	clear
VOSU-WU-M-365-TAPE	Tape		

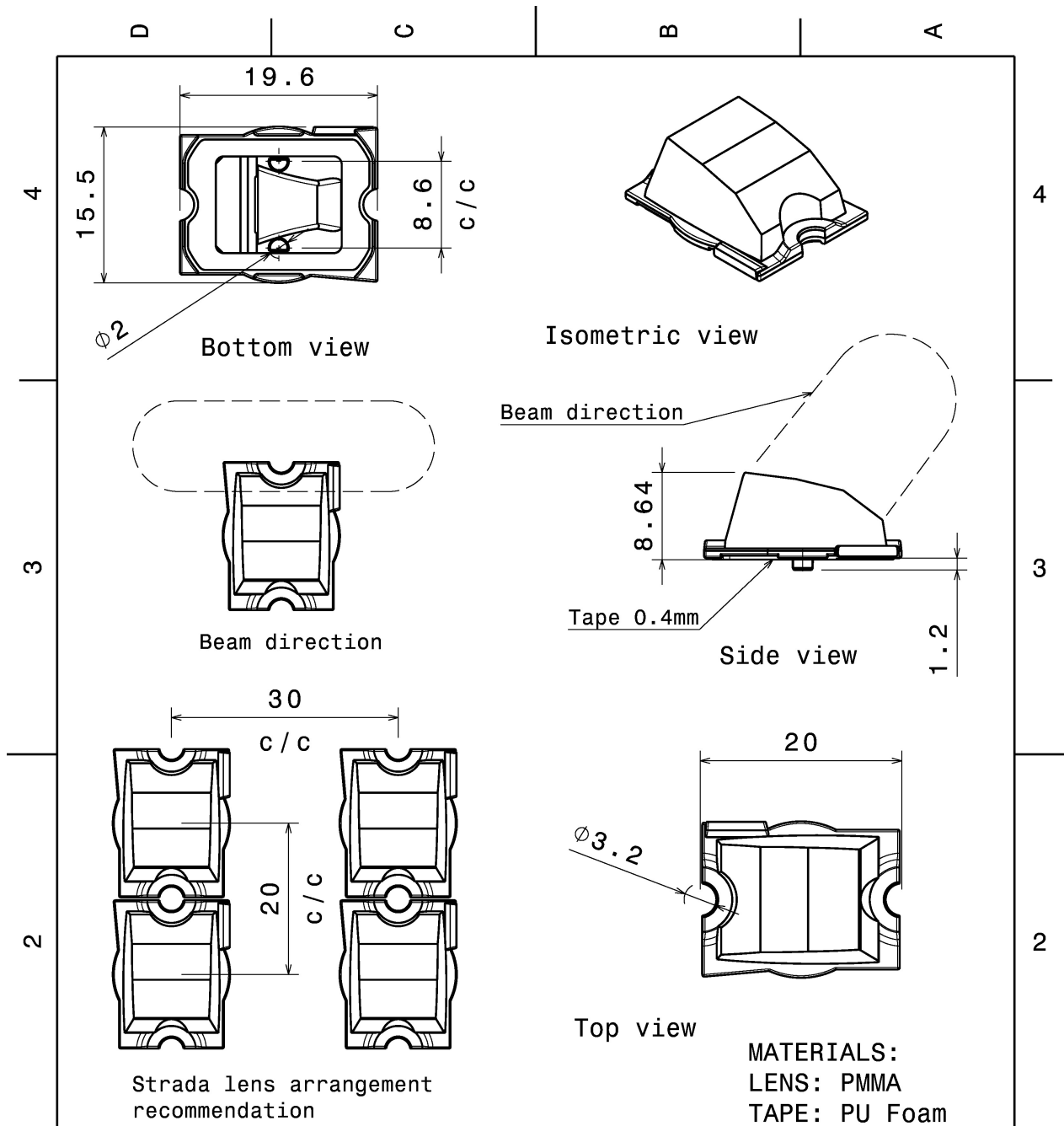

Tolerances if not otherwise shown
According to DIN ISO 2768-1
Linear measures: class C
According to DIN ISO 2768-2
Form and position: class L

LEDiL Ledil Oy
Salorankatu 10
FIN 24240 SALO
Finland

THIRD ANGLE PROJECTION:

DRAWING TITLE
CA11416_STRADA-T-DN

This drawing is the property of LEDiL Oy. It may not be reproduced, copied or communicated without a written agreement with LEDiL Oy."

SIZE	PART NUMBER
A4	CA11416

SCALE	2:1	WEIGHT	1,31 g	SHEET	1/1
-------	-----	--------	--------	-------	-----

PHOTOMETRIC DATA (MEASURED):

CREE

LED XB-D
FWHM Asymmetric
Efficiency 91 %
Peak intensity cd/lm
LEDs/each optic 1
Light colour White
Required components:

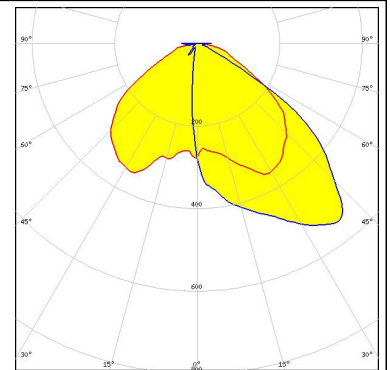

CREE

LED XP-E
FWHM Asymmetric
Efficiency 92 %
Peak intensity cd/lm
LEDs/each optic 1
Light colour White
Required components:

CREE

LED XP-G
FWHM Asymmetric
Efficiency 92 %
Peak intensity cd/lm
LEDs/each optic 1
Light colour White
Required components:

LG Innotek

LED H35B0 (LEMWA32)
FWHM Asymmetric
Efficiency 91 %
Peak intensity 0.500 cd/lm
LEDs/each optic 1
Light colour White
Required components:

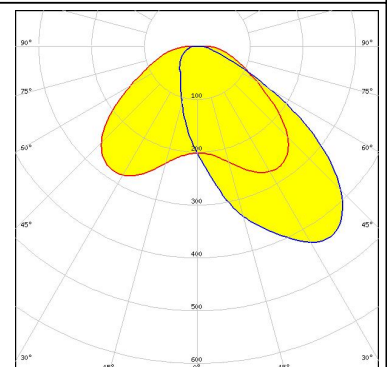

PHOTOMETRIC DATA (MEASURED):

LG Innotek

LED H35C0 (LEMWA33)
FWHM Asymmetric
Efficiency 89 %
Peak intensity 0.490 cd/lm
LEDs/each optic 1
Light colour White
Required components:

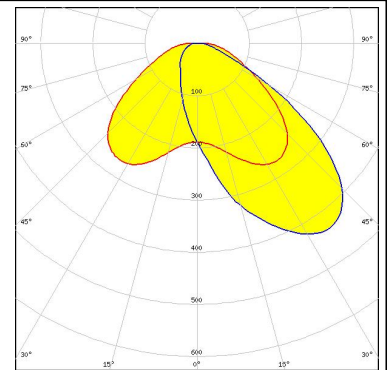

LUMILEDS

LED LUXEON A
FWHM Asymmetric
Efficiency 92 %
Peak intensity cd/lm
LEDs/each optic 1
Light colour White
Required components:

LUMILEDS

LED LUXEON Rebel
FWHM Asymmetric
Efficiency 92 %
Peak intensity cd/lm
LEDs/each optic 1
Light colour White
Required components:

LUMILEDS

LED LUXEON Rebel ES
FWHM Asymmetric
Efficiency 92 %
Peak intensity cd/lm
LEDs/each optic 1
Light colour White
Required components:

PHOTOMETRIC DATA (MEASURED):

LUMILEDS

LED LUXEON TX
FWHM Asymmetric
Efficiency 91 %
Peak intensity 0.500 cd/lm
LEDs/each optic 1
Light colour White
Required components:

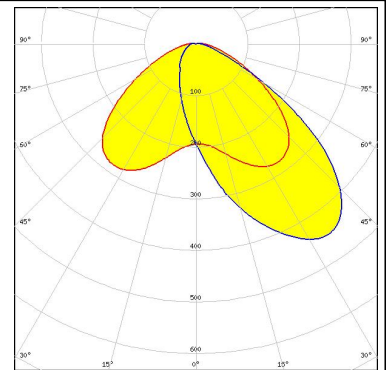

LUMILEDS

LED LUXEON Z ES
FWHM Asymmetric
Efficiency 90 %
Peak intensity 0.500 cd/lm
LEDs/each optic 1
Light colour White
Required components:

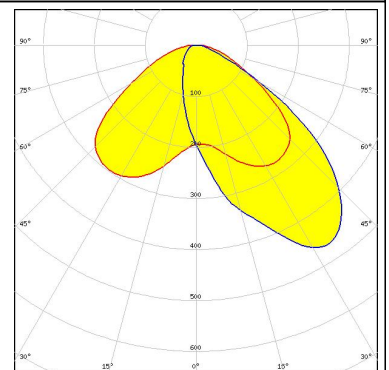

NICHIA

LED NCSxx19A
FWHM Asymmetric
Efficiency 92 %
Peak intensity cd/lm
LEDs/each optic 1
Light colour White
Required components:

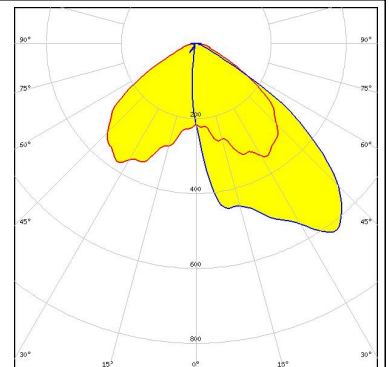

NICHIA

LED NVSxx19A
FWHM Asymmetric
Efficiency 92 %
Peak intensity cd/lm
LEDs/each optic 1
Light colour White
Required components:

PHOTOMETRIC DATA (MEASURED):

OSRAM

Opto Semiconductors

LED Oslon Square PC
 FWHM Asymmetric
 Efficiency 93 %
 Peak intensity cd/lm
 LEDs/each optic 1
 Light colour White
 Required components:

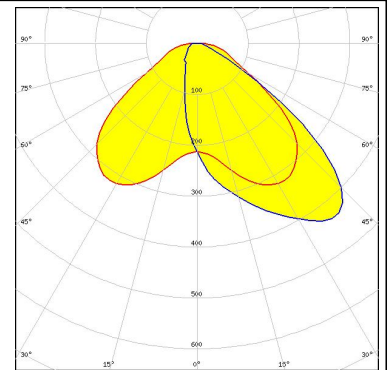

OSRAM

Opto Semiconductors

LED Oslon SSL 150
 FWHM Asymmetric
 Efficiency 92 %
 Peak intensity cd/lm
 LEDs/each optic 1
 Light colour White
 Required components:

SEOL

SEOL SEMICONDUCTOR

LED Z5
 FWHM Asymmetric
 Efficiency 92 %
 Peak intensity cd/lm
 LEDs/each optic 1
 Light colour White
 Required components:

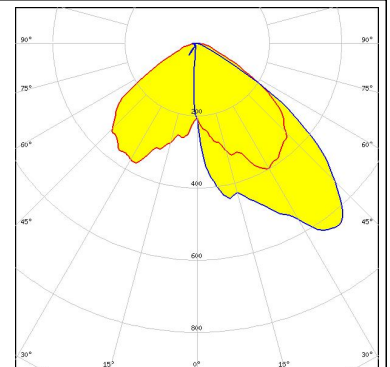

SEOL

SEOL SEMICONDUCTOR

LED Z5M1/Z5M2
 FWHM Asymmetric
 Efficiency 92 %
 Peak intensity 0.500 cd/lm
 LEDs/each optic 1
 Light colour White
 Required components:

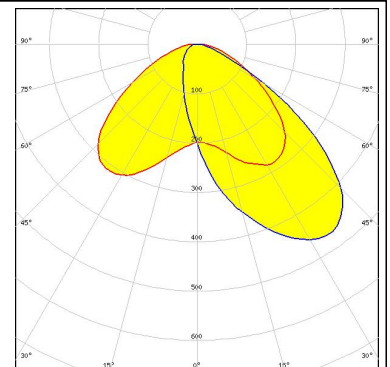

PHOTOMETRIC DATA (MEASURED):

SHARP

LED	Double Dome (GM2BB)
FWHM	Asymmetric
Efficiency	92 %
Peak intensity	cd/lm
LEDs/each optic	1
Light colour	White
Required components:	

PHOTOMETRIC DATA (SIMULATED):



LED LUXEON T
FWHM Asymmetric
Efficiency 91 %
Peak intensity cd/lm
LEDs/each optic 1
Light colour White
Required components:

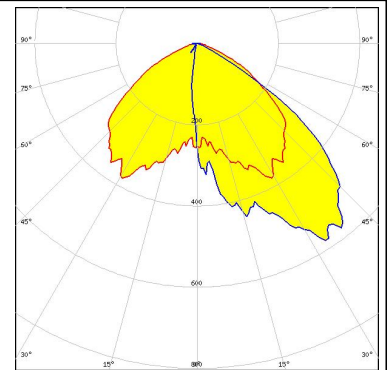

LED NVSxx19B/NVSxx19C
FWHM Asymmetric
Efficiency 90 %
Peak intensity cd/lm
LEDs/each optic 1
Light colour White
Required components:

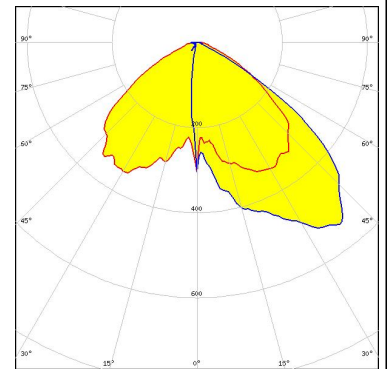

Osram Semiconductors
LED Oslon SSL 80
FWHM Asymmetric
Efficiency 93 %
Peak intensity 0.670 cd/lm
LEDs/each optic 1
Light colour White
Required components:

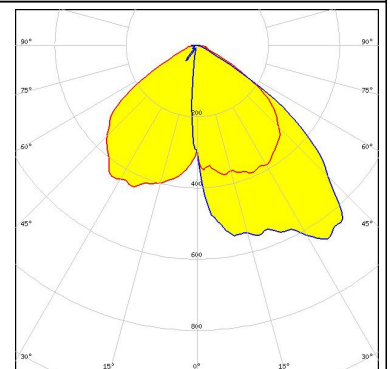

GENERAL INFORMATION:

NOTE: The typical beam angle will be changed by different color, chip size and chip position tolerance. The typical total beam angle is the full angle measured where the luminous intensity is half of the peak value.

MATERIALS:

As part of our continuous research and improvement processes, and to ensure the best possible quality and availability of our products, LEDiL reserves the right to change material grades without notice.

PRODUCT DATA USER AGREEMENT AND DISCLAIMER:

The measured data in the provided downloadable LEDiL Product Datasheets and Mechanical 2D-Drawings is rounded and provided as reference for planning. LEDiL Oy's optical specifications have been verified by conducting performance testing of the products in accordance with the company's quality system. The reported data are averaged results of multiple measurements with typical variation. LEDiL Oy reserves the right to without prior notification make changes and improvements to its products.

LEDiL Oy assumes neither warranty, nor guarantee nor any other liability of any kind for the contents and correctness of the provided data. The provided data has been generated with highest diligence but the provided data may in reality not represent the complete possible variation range of all intrinsic parameters. Therefore, in certain cases a deviation from the provided data could occur.

LEDiL Oy reserves the right to undertake technical changes of its products without further notification which could lead to changes in the provided data. LEDiL Oy assumes no liability of any kind for the possible deviation from any provided data or any other damage resulting from the usage of the provided data.

The user agrees to this disclaimer and user agreement with the download or usage of the provided files.

LEDiL Oy

Joensuunkatu 13
FI-24240 SALO
Finland

LEDiL Inc.

228 West Page Street
Suite D
Sycamore IL 60178
USA

Local sales and technical support

[www.ledil.com/
where_to_buy](http://www.ledil.com/where_to_buy)

Shipping locations

Salo, Finland
Hong Kong, China

Distribution Partners

[www.ledil.com/
where_to_buy](http://www.ledil.com/where_to_buy)