

### 96 W, Efficient, Compact Non-Dimmable CV Class 2 / Class II LED Drivers

Nominal Input Voltage	Max. Output Power	Nominal Output Voltage	Max. Output Current	Efficiency	Max. Case Temperature	THD	Power Factor
120 & 277 Vac, 220 to 240 Vac	96 W	12, 24, 48 Vdc	8, 4, 2 A	up to 92% typical	90°C (measured at the hot spot)	< 20%	> 0.9

#### Models with Flying Leads, Aluminum Case:

L 137 x W 26.0 x H 19.8 mm  
(L 5.39 x W 1.02 x H 0.77 in)

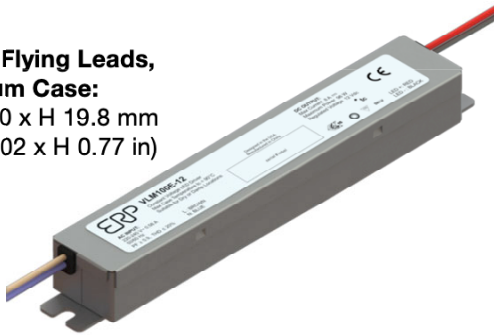

#### Models with "-S" Suffix, Bottom Leads with Studs, Aluminum Case:

L 137 x W 26.0 x H 23.85 mm  
(L 5.39 x W 1.02 x H 0.94 in)

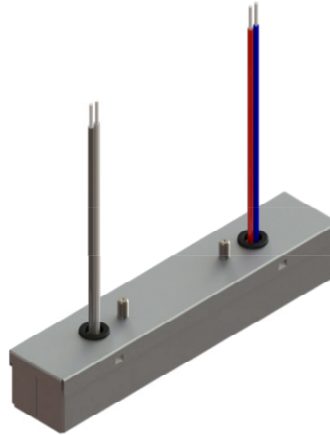

#### Models with "-T" Suffix (Terminal Blocks), Aluminum Case:

L 193.2 x W 26.2 x H 19.85 mm  
(L 7.60 x W 1.03 x H 0.78 in)



Typical Application Diagram

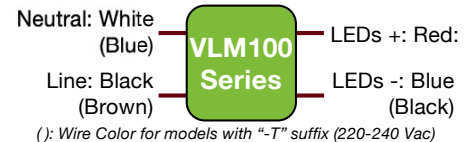

( ): Wire Color for models with "-T" suffix (220-240 Vac)

Wiring Diagram

#### TYPICAL APPLICATIONS

- Strip lights
- Pendants
- Linears
- Cove Lights

#### FEATURES

- Very high power density of 24 W/in<sup>3</sup>
- Class 2 power supply
- Class II power supply per IEC 61347
- IP20-rated case with silicone-based potting
- 90°C maximum case hot spot temperature
- Complies with ENERGY STAR®, DLC (DesignLight Consortium®) and CA Title 24 technical requirements
- Lifetime: 50,000 hours min at 70°C case temperature
- UL Class P
- Worldwide safety approvals SELV Class 2
- Additional safety approvals when using the optional strain reliefs for models with "-T" suffix



## 96 W, Efficient, Compact Non-Dimmable CV Class 2 / Class II LED Drivers

### 1 - ORDERING INFORMATION

ERP Part Number	Nominal Input Voltage (Vac)	Pout Max (W)	Vout Nom (Vdc)	Iout Min (A)	Iout Max (A)	Open Loop Voltage (No Load Vout Max) (Vdc)	Comments
<b>120/277 VAC NOMINAL VOLTAGE</b>							
VLM100W-12 <sup>(1)</sup>	120 & 277	96	12	0.2	8	12.84	Aluminum case with flying leads
VLM100W-24	120 & 277	96	24	0.2	4	25.68	Aluminum case with flying leads
VLM100W-48	120 & 277	96	48	0.1	2	51.36	Aluminum case with flying leads
VLM100W-12-S <sup>(1)</sup>	120 & 277	96	12	0.2	8	12.84	Aluminum case with bottom leads and studs
VLM100W-24-S	120 & 277	96	24	0.2	4	25.68	Aluminum case with bottom leads and studs
VLM100W-48-S	120 & 277	96	48	0.1	2	51.36	Aluminum case with bottom leads and studs
<b>220 TO 240 VAC NOMINAL VOLTAGE</b>							
VLM100E-12	220 to 240	96	12	0.2	8	12.84	Aluminum case with flying leads
VLM100E-24	220 to 240	96	24	0.2	4	25.68	Aluminum case with flying leads
VLM100E-48	220 to 240	96	48	0.1	2	51.36	Aluminum case with flying leads
VLM100E-12-T	220 to 240	96	12	0.2	8	12.84	Aluminum case with terminal blocks
VLM100E-24-T	220 to 240	96	24	0.2	4	25.68	Aluminum case with terminal blocks
VLM100E-48-T	220 to 240	96	48	0.1	2	51.36	Aluminum case with terminal blocks

(1): VLM100W-12 is not Class 2 because the over-current protection of this model exceeds the 5A UL Class 2 limit.

## 96 W, Efficient, Compact Non-Dimmable CV Class 2 / Class II LED Drivers

### 2 - INPUT SPECIFICATION (@25° C ambient temperature)

	Units	Minimum	Typical	Maximum	Notes
<b>Input Voltage Range (Vin)</b> - VLM100W models	Vac	90	120 & 277	305	•The rated output voltage for each model is achieved at $V_{in} \geq 105$ Vac & at $V_{in} \geq 249$ Vac for VLM100W models, and at $V_{in} \geq 209$ Vac for VLM100E models.
- VLM100E models		198	230	264	•At maximum load, as specified in section 1.
<b>Input Frequency Range</b> - VLM100W models	Hz	47	60	63	
- VLM100W models		47	50	53	
<b>Input Current (Iin)</b>	A			1.05 A @ 120 Vac 0.58 A @ 230 vac 0.48 A @ 277 Vac	
<b>Power Factor (PF)</b>		0.9	> 0.9		•At nominal input voltage •From 100% to 60% of rated power
<b>Inrush Current</b>	A	Meets NEMA-410 requirements			•At any point on the sine wave and 25°C
<b>Leakage Current</b>	µA			400 µA @ 120 Vac 800 µA @ 230 Vac 920 µA @ 277 Vac	Measured per IEC60950-1
<b>Input Harmonics</b>	Complies with IEC61000-3-2 for Class C equipment				
<b>Total Harmonics Distortion (THD)</b>				20%	•At nominal input voltage •From 100% to 60% of rated power •Complies with DLC (Design Light Consortium) technical requirements
<b>Efficiency</b>	%	-	up to 92%	-	Measured with nominal input voltage
<b>Isolation</b>	The AC input to the main DC output is isolated				

### 3 - MAIN OUTPUT SPECIFICATION (@25° C ambient temperature)

	Units	Minimum	Typical	Maximum	Notes
<b>Output Voltage (Vout)</b>	Vdc		12, 24, 48		See ordering information for details
<b>Output Current (Iout)</b>	A			12 Vdc: 8 A 24 Vdc: 4 A 48 Vdc: 2 A	The rated output voltage for each model is achieved at $V_{in} \geq 105$ Vac & at $V_{in} \geq 249$ Vac for VLM100W models, and at $V_{in} \geq 209$ Vac for VLM100E models.
<b>Output Voltage Regulation</b>	%	-5		5	•At nominal AC line voltage •Includes load and current set point variations.
<b>Output Voltage Overshoot</b>	%	-	-	10	The driver does not operate outside of the regulation requirements for more than 500 ms during power on with maximum load.
<b>Ripple Voltage</b>	≤ 5% of rated output voltage for each model				•Measured at maximum load and nominal input voltage. •Calculated in accordance with the IES Lighting Handbook, 9th edition.
<b>Start-up Time</b>	ms			500	•Measured from application of AC line voltage to 100% light output. •Complies with ENERGY STAR® luminaire specification.

# 96 W, Efficient, Compact Non-Dimmable CV Class 2 / Class II LED Drivers

### 4 - ENVIRONMENTAL CONDITIONS

	Units	Minimum	Typical	Maximum	Notes
<b>Operating Ambient Temperature (Ta)</b>	°C	-20		50	50°C is the non-derated temperature (Refer to section 7 "Output power de-rating at higher temperatures".
<b>Maximum Case Temperature (Tc)</b>	°C			+90	Case temperature measured at the hot spot •tc (see label in page 13)
<b>Storage Temperature</b>	°C	-40		+85	
<b>Humidity</b>	%	5	-	95	Non-condensing
<b>Cooling</b>	Convection cooled				
<b>Acoustic Noise</b>	dBA			22	Measured at a distance of 1 foot (30 cm)
<b>Mechanical Shock Protection</b>	per EN60068-2-27				
<b>Vibration Protection</b>	per EN60068-2-6 & EN60068-2-64				
<b>MTBF</b>	> 200,000 hours when operated at nominal input and output conditions, and at Tc ≤ 70°C				
<b>Lifetime</b>	50,000 hours at Tc ≤ 70°C maximum case hot spot temperature (see hot spot •tc on label in page 13)				

### 5 - EMC COMPLIANCE AND SAFETY APPROVALS

#### EMC Compliance

<b>Conducted and Radiated EMI</b>	<ul style="list-style-type: none"> <li>•VLM100W models: Compliant with FCC CFR Title 47 Part 15 Class B at 120 Vac &amp; Class A at 277 Vac</li> <li>•VLM100E models: Compliant with EN55015 (CISPR 15) at 220, 230, and 240 Vac</li> </ul>				
<b>Harmonic Current Emissions</b>	IEC61000-3-2	For Class C equipment			
<b>Voltage Fluctuations &amp; Flicker</b>	IEC61000-3-3				
<b>Immunity Compliance</b>	<b>ESD (Electrostatic Discharge)</b>	IEC61000-4-2	6 kV contact discharge, 8 kV air discharge, level 3		
	<b>RF Electromagnetic Field Susceptibility</b>	IEC61000-4-3	3 V/m, 80 - 1000 MHz, 80% modulated at a distance of 3 meters		
	<b>Electrical Fast Transient</b>	IEC61000-4-4	± 2 kV on AC power port for 1 minute, ±1 kV on signal/control lines		
	<b>Surge</b>	IEC61000-4-5	± 2 kV line to line (differential mode) / ± 2 kV line to common mode ground (tested to secondary ground) on AC power port, ±0.5 kV for outdoor cables		
			ANSI/IEEE c62.41.1-2002 & c62.41.2-2002 category A, 2.5 kV ring wave		
	<b>Conducted RF Disturbances</b>	IEC61000-4-6	3V, 0.15-80 MHz, 80% modulated		
<b>Voltage Dips</b>	IEC61000-4-11	>95% dip, 0.5 period; 30% dip, 25 periods; 95% reduction, 250 periods			

#### Safety Agency Approvals

<b>UL</b>	VLM100W models: UL8750 listed Class 2
<b>cUL</b>	VLM100W models: CAN/CSA C22.2 No. 250.13-14 LED equipment for lighting applications
<b>CE</b>	VLM100E models: IEC61347-2-13 electronic control gear for LED Modules & EN55015 (EMC compliance)
<b>CB</b>	VLM100E models
<b>ENEC</b>	VLM100E models

#### Safety

	Units	Minimum	Typical	Maximum	Notes
<b>Hi Pot (High Potential) or Dielectric voltage-withstand</b> - VLM100W models	Vdc	2500			<ul style="list-style-type: none"> <li>•Insulation between the input (AC line and Neutral) and the output</li> <li>•Tested at the RMS voltage equivalent of 1768 Vac</li> </ul>
- VLM100E models		4242			<ul style="list-style-type: none"> <li>•Tested at the RMS voltage equivalent of 3000 Vac</li> <li>•Meets class II reinforced/double insulation </li> </ul>

# 96 W, Efficient, Compact Non-Dimmable CV Class 2 / Class II LED Drivers

## 6 - PROTECTION FEATURES

### Under-Voltage (Brownout)

The VLM100 series provides protection circuitry such that an application of an input voltage below the minimum stated in section 1 (Input Specification) shall not cause damage to the driver.

### Short Circuit and Over Current Protection

The VLM100 series is protected against short-circuit such that a short from any output to return shall not result in a fire hazard or shock hazard. The driver shall hiccup as a result of a short circuit or over current fault. Removal of the fault will return the driver to within normal operation. The driver shall recover, with no damage, from a short across the output for an indefinite period of time.

### Internal Over temperature Protection

The VLM100 is equipped with an internal temperature sensor on the primary power train. Failure to stay within the convection power rating will cause the driver to shut down. The main output current will be resumed when the temperature of the built-in temperature sensor cools adequately.

### Output Open Load

A no load condition will not damage the VLM100 or cause a hazardous condition. The driver will remain stable and operate normally after application of a load. When the LED load is removed, the output voltage of the VLM100 series is limited to 7% about the output voltage of each model.

### Over Power Protection

The VLM100 will shut down and auto recover in the event of an over-power condition. This condition will cause no damage to the power supply.

### Input Over Current Protection

The VLM100 series incorporates a primary AC line fuse for input over current protection.

## 7 - OUTPUT POWER DE-RATING AT ELEVATED TEMPERATURES

The VLM100 series can be operated with cooling air temperatures above 50°C by linearly de-rating the total maximum output power (or current) by 2.5%/°C from 50°C to 70°C (see figure 1).

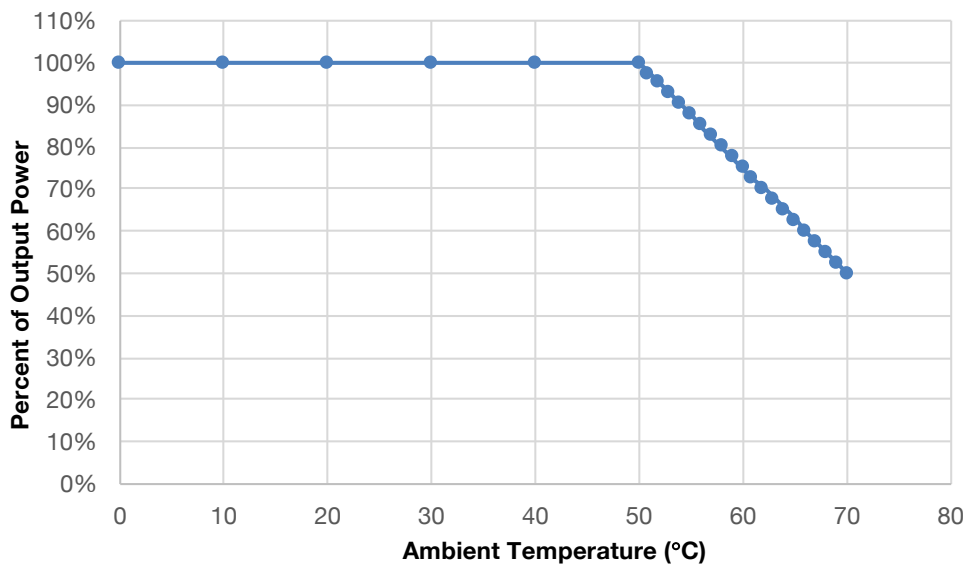

Figure 1

# 96 W, Efficient, Compact Non-Dimmable CV Class 2 / Class II LED Drivers

### 8 - PREDICTED LIFETIME VERSUS CASE AND AMBIENT TEMPERATURE

Lifetime is defined by the measurement of the temperatures of all the electrolytic capacitors whose failure would affect light output under the nominal LED load and worst case AC line voltage. The graphs in figures 2 and 3 are determined by the electrolytic capacitor with the shortest lifetime, among all electrolytic capacitors. It represents a worst case scenario in which the LED driver is powered 24 hours/day, 7 days/week. The lifetime of an electrolytic capacitor is measured when any of the following changes in performance are observed:

- 1) Capacitance changes more than 20% of initial value
- 2) Dissipation Factor ( $\tan \delta$ ): 150% or less of initial specified value
- 3) Equivalent Series Resistance (ESR): 150% or less of initial specified value
- 4) Leakage current: less of initial specified value

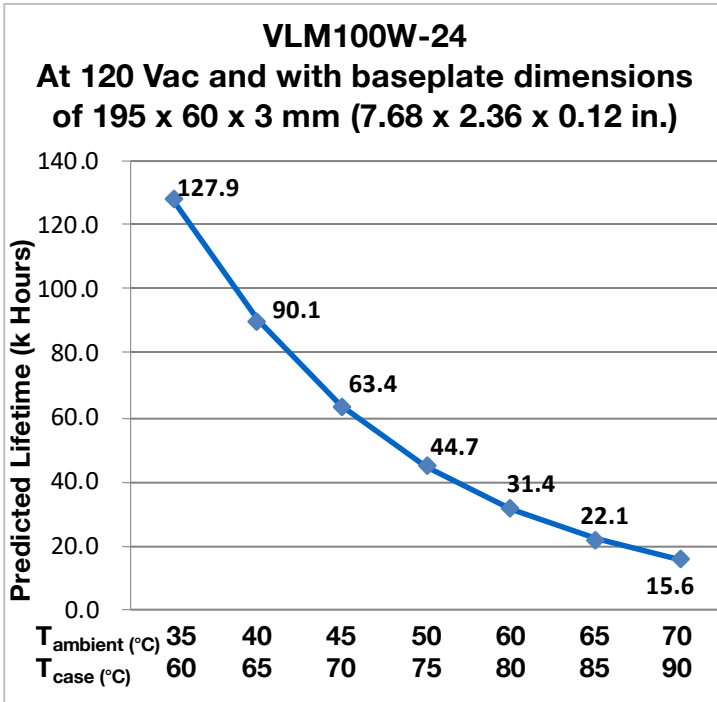

Figure 2

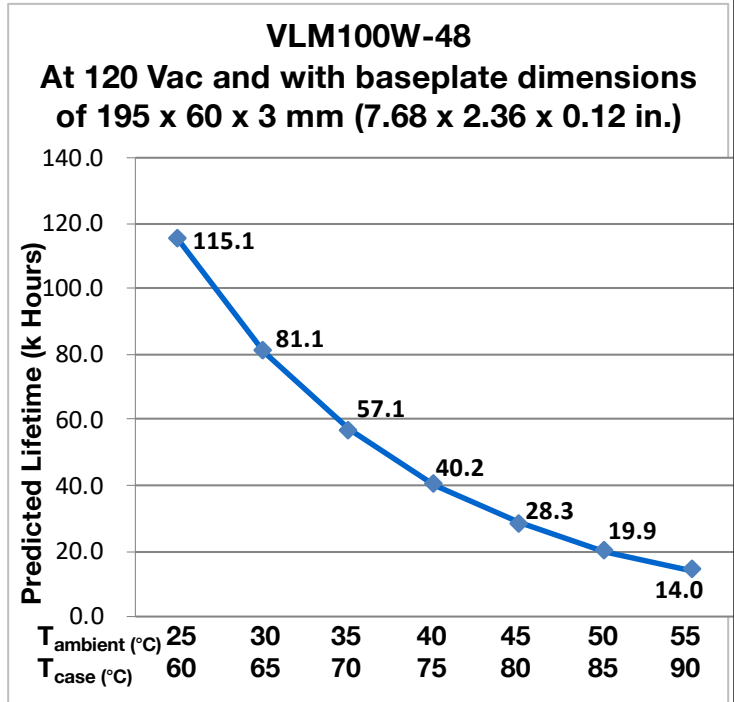

Figure 3

**Notes:**

- The ambient temperature  $T_{\text{ambient}}$  and the differential between  $T_{\text{ambient}}$  and  $T_{\text{case}}$  mentioned in the above graphs are relevant only as long as both the driver and the light fixture are exposed to the same ambient room temperature. If the LED driver is housed in an enclosure or covered by insulation material, then the ambient room temperature is no longer valid. In this situation, please refer only to the case temperature  $T_{\text{case}}$ .
- It should be noted the graph "Lifetime vs. Ambient Temperature" may have an error induced in the final application if the mounting has restricted convection flow around the case. For applications where this is evident, the actual case temperature measured at the  $T_c$  point in the application should be used for reliability calculations.

### 96 W, Efficient, Compact Non-Dimmable CV Class 2 / Class II LED Drivers

#### 9 – EFFICIENCY VERSUS LOAD

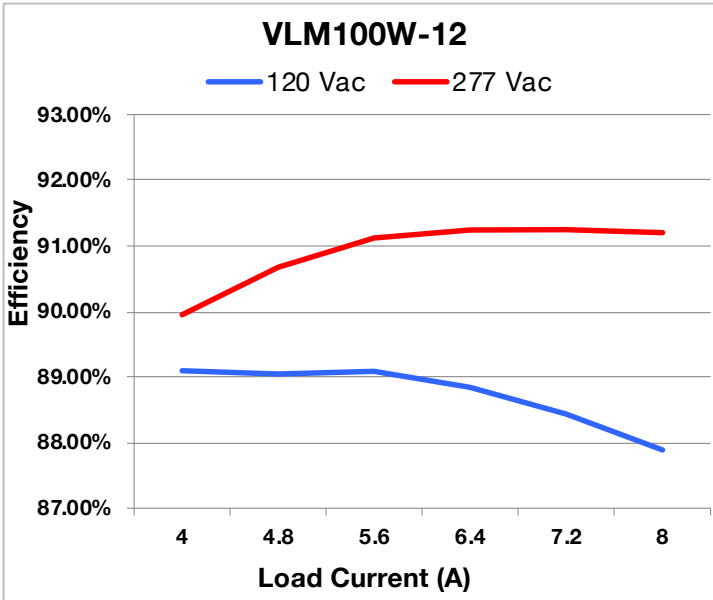

Figure 4

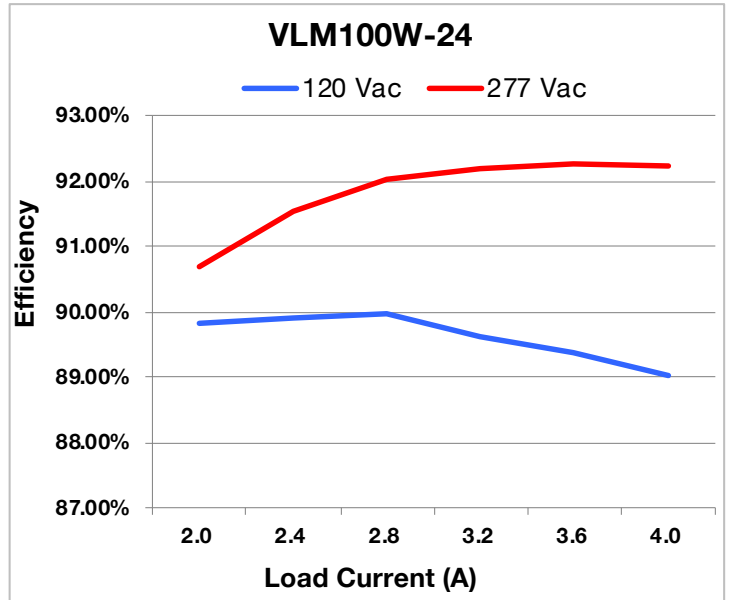

Figure 5

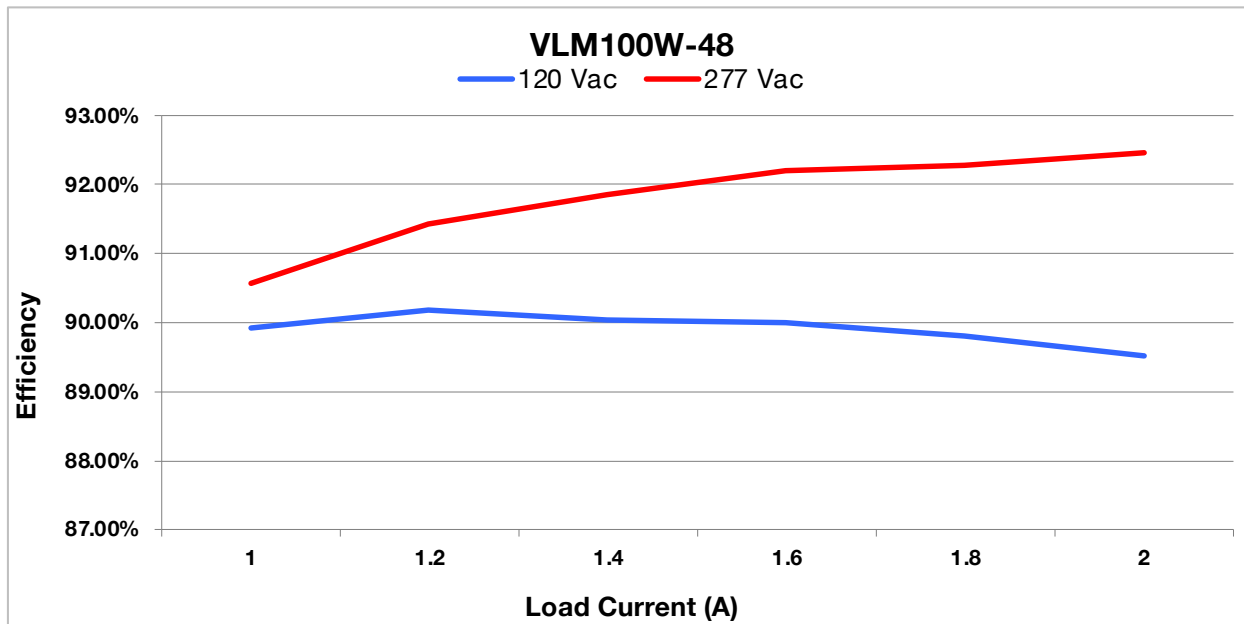

Figure 6

### 96 W, Efficient, Compact Non-Dimmable CV Class 2 / Class II LED Drivers

10 – POWER FACTOR VERSUS LOAD

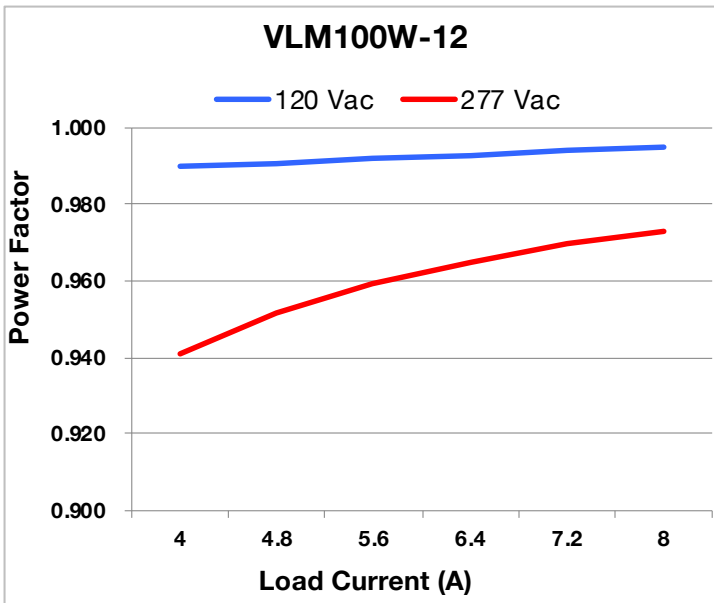

Figure 7

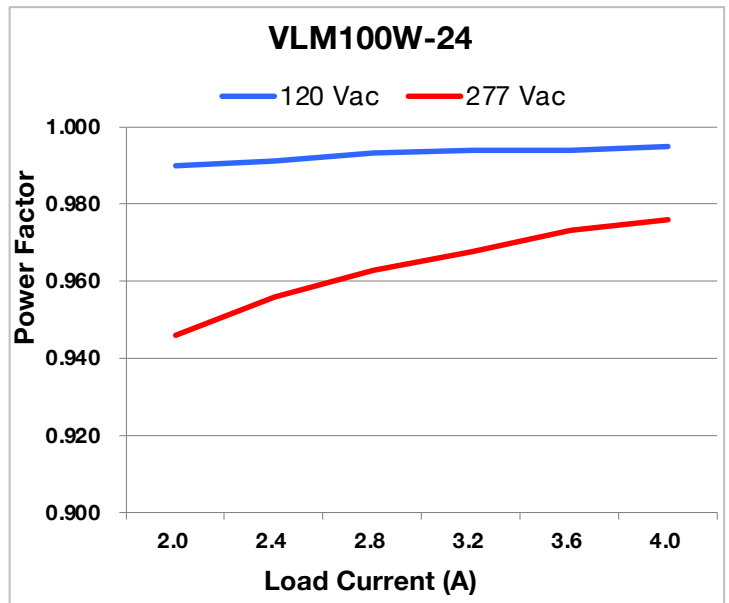

Figure 8

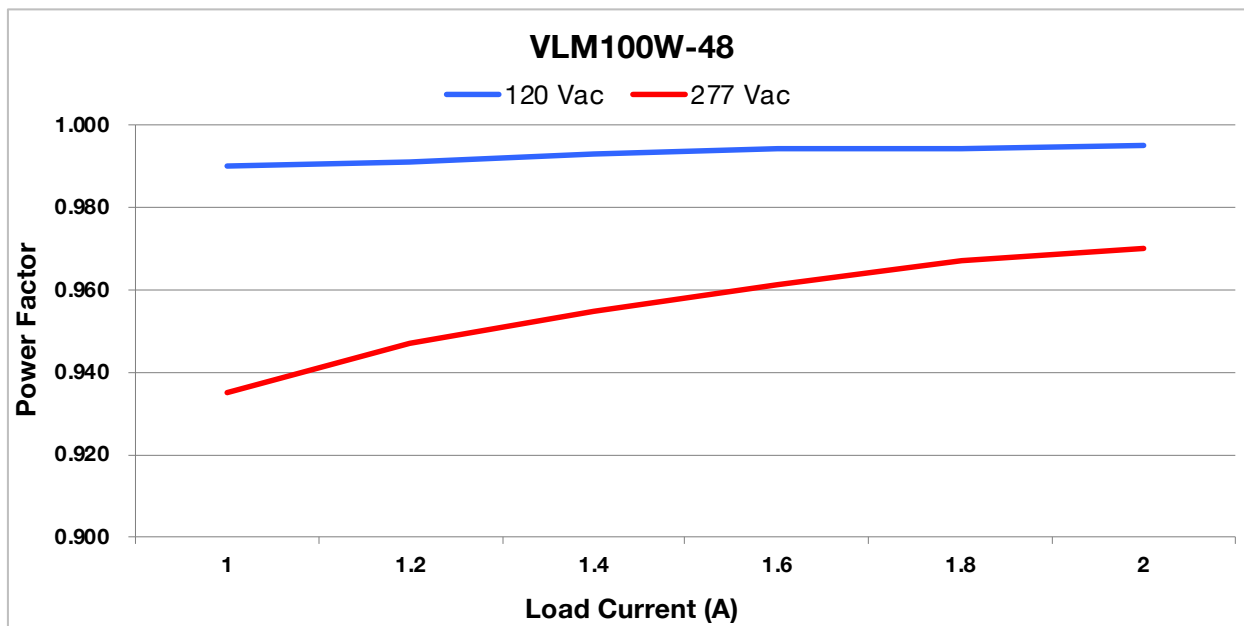

Figure 9



### 96 W, Efficient, Compact Non-Dimmable CV Class 2 / Class II LED Drivers

#### 11 - THD VERSUS LOAD

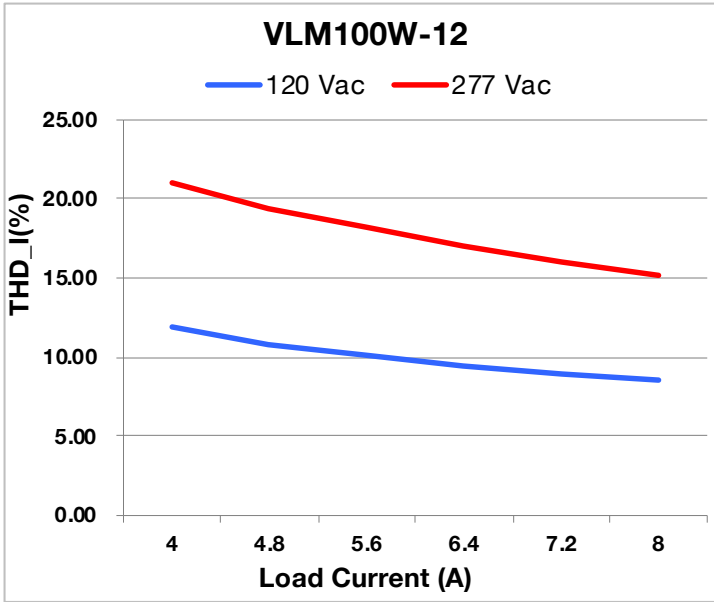

Figure 10

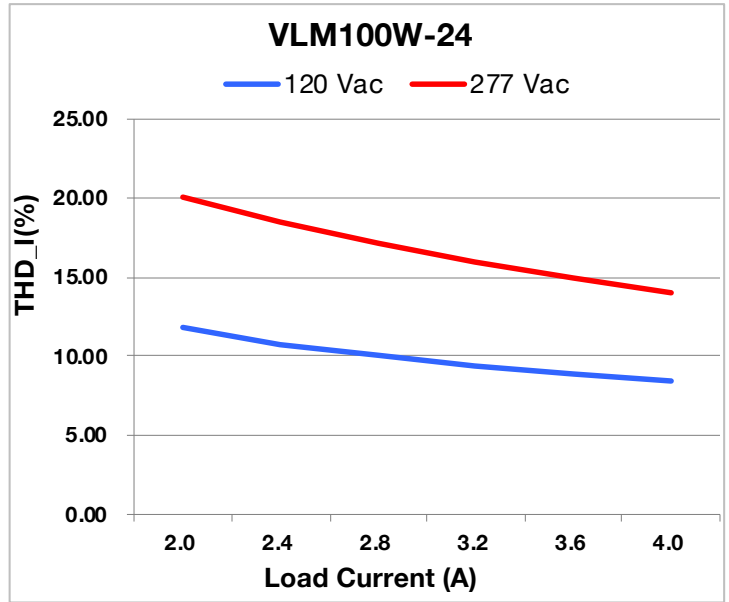

Figure 11

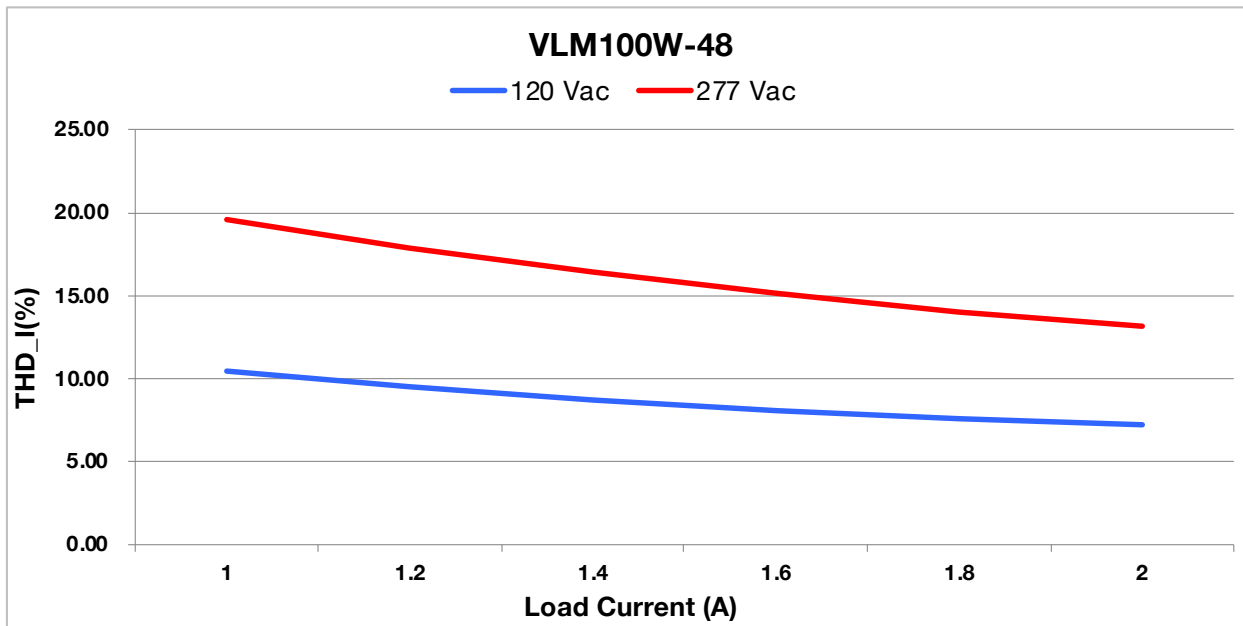

Figure 12

# 96 W, Efficient, Compact Non-Dimmable CV Class 2 / Class II LED Drivers

### 12 - MECHANICAL DETAILS

- **Packaging Options:** Aluminum case
- **I/O Connections:**
  - **Models with flying leads:** 18 AWG on all leads, 203mm (8 in) long, 105°C rated, stranded, stripped by approximately 9.5mm, and tinned. All the wires, on both input and output, have a 300 V insulation rating.
  - **Models with “-S” suffix:** Terminal Blocks
  - **Models with “T” suffix:** Terminal Blocks
- **Ingress Protection:** IP20 rated
- **Mounting Instructions:** The VLM100 driver case must be secured on a flat surface through the two mounting tabs, shown here below in the case outline drawings. We recommended mounting the VLM100 on a baseplate with dimensions of 195 x 60 x 3 mm (7.68 x 2.36 x 0.12 in.).

### 13 - OUTLINE DRAWINGS (MODELS WITH FLYING LEADS)

**Dimensions:** L 137 x W 26.0 x H 19.8 mm (L 5.39 x W 1.02 x H 0.78 in)

**Volume:** 70.53 cm<sup>3</sup> (4.30 in<sup>3</sup>)

**Weight:**

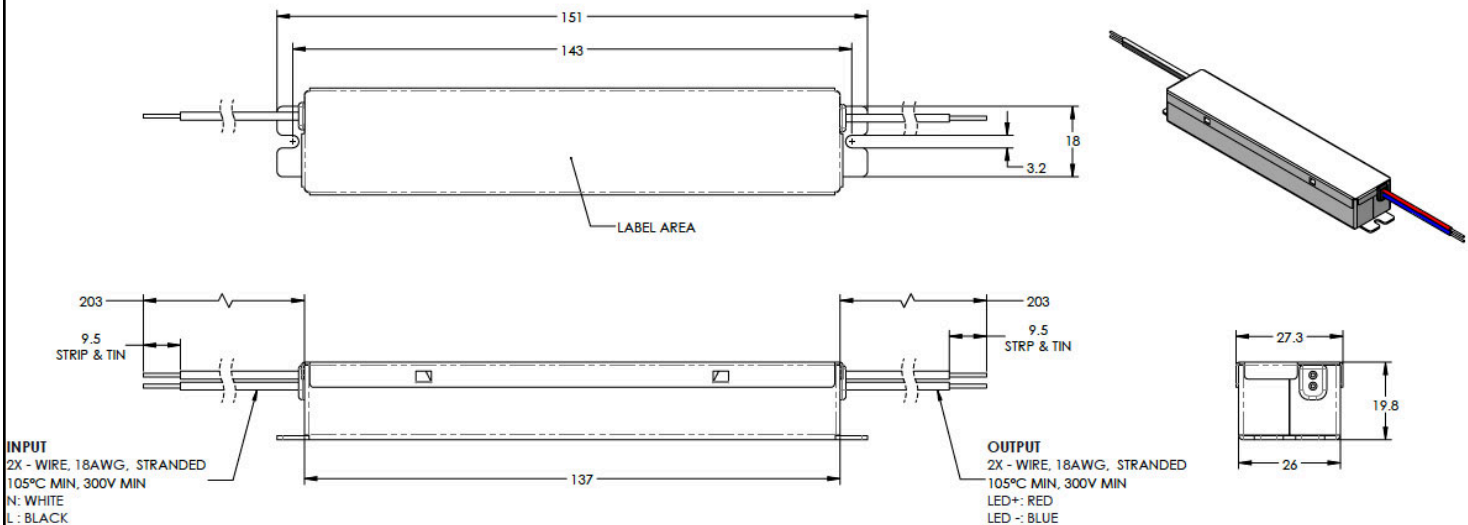

All dimensions are in mm

Figure 13

# 96 W, Efficient, Compact Non-Dimmable CV Class 2 / Class II LED Drivers

### 14 - OUTLINE DRAWINGS (MODELS WITH "-T" SUFFIX)

**Dimensions:** L 193.2 x W 26.2 x H 19.85 mm (L 7.60 x W 1.03 x H 0.78 in)

**Weight:**

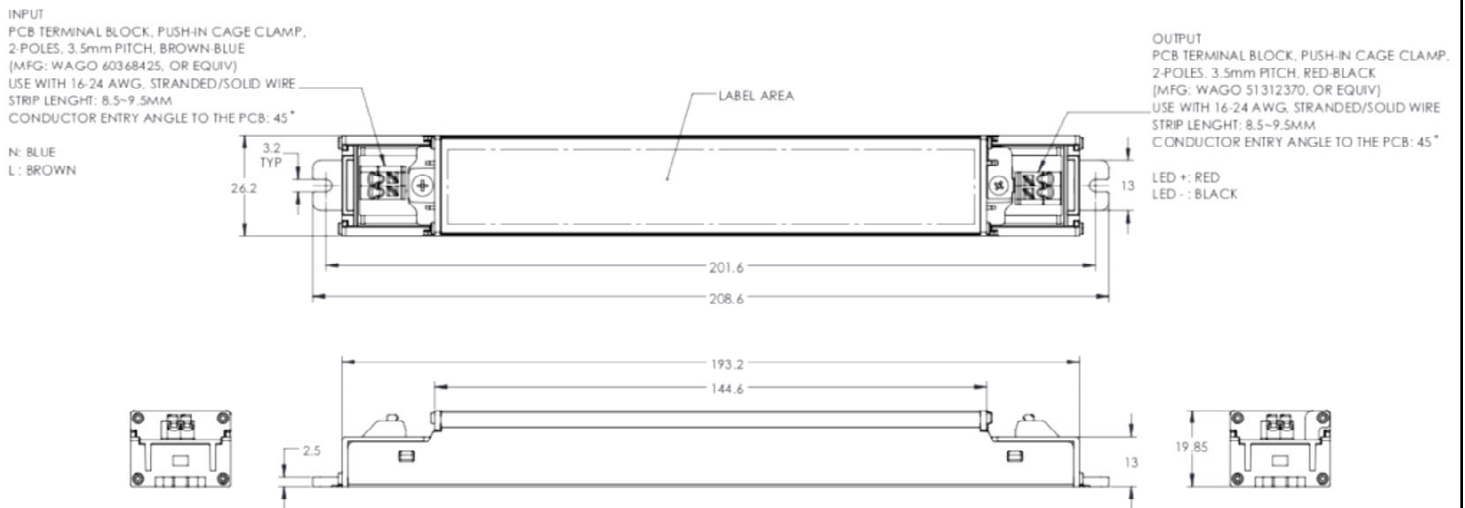

All dimensions are in mm

**Figure 14**

## 96 W, Efficient, Compact Non-Dimmable CV Class 2 / Class II LED Drivers

### 15 - OUTLINE DRAWINGS (MODELS WITH "-T" SUFFIX AND STRAIN RELIEFS)

**Dimensions:** L 251.6 x W 26.2 x H 19.85 mm (L 9.91 x W 1.03 x H 0.78 in)

**Weight:**

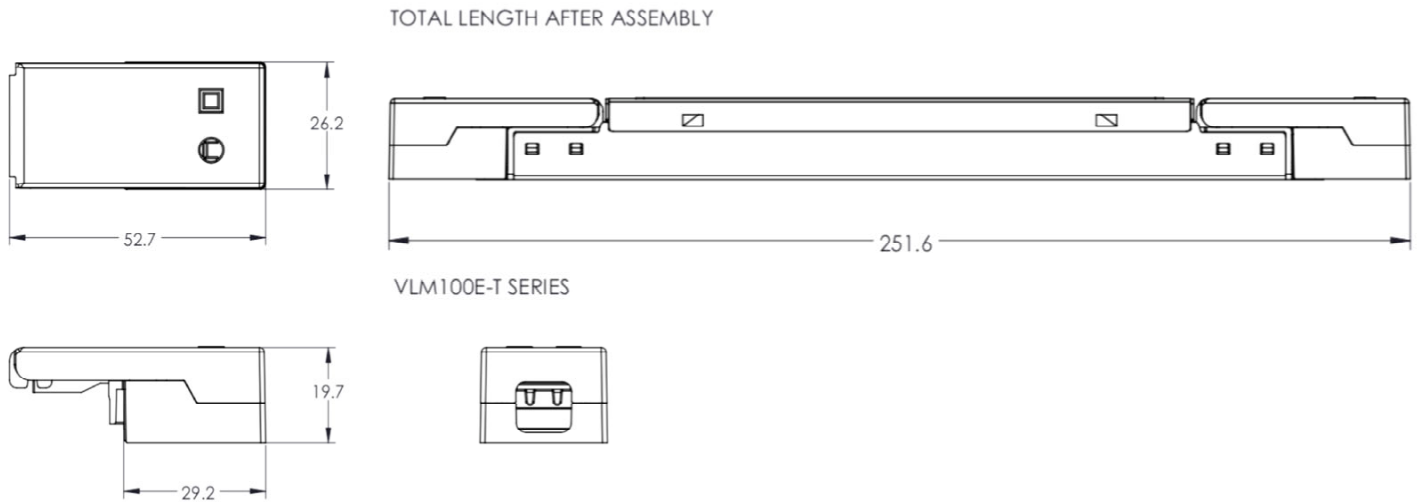

All dimensions are in mm

**Figure 15**

### 96 W, Efficient, Compact Non-Dimmable CV Class 2 / Class II LED Drivers

16 - OUTLINE DRAWINGS (MODELS WITH "-S" SUFFIX)

**Dimensions:** L 137 x W 26.0 x H 23.85 mm (L 5.39 x W 1.02 x H 0.94 in)

**Weight:**

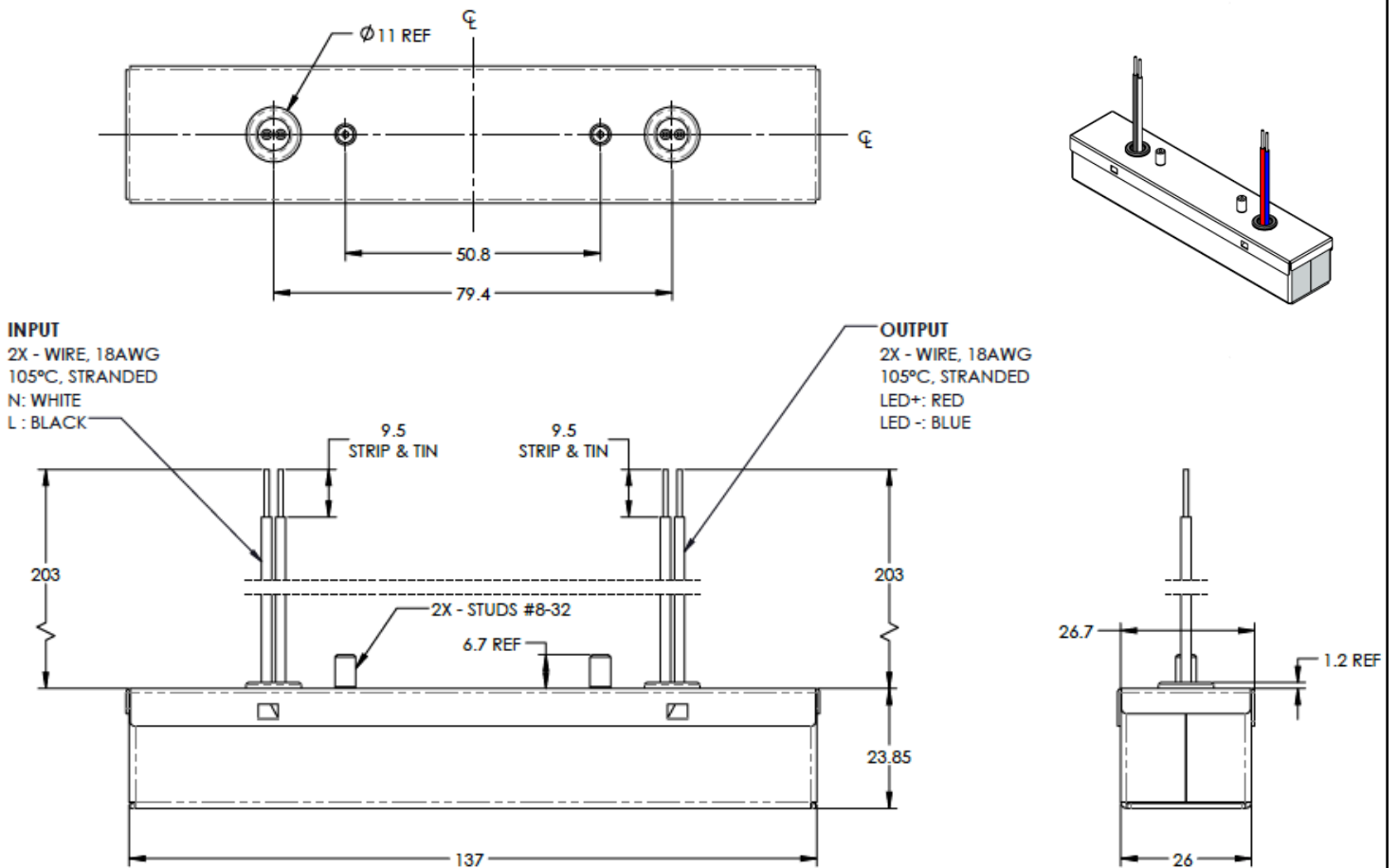

All dimensions are in mm

Figure 16

# 96 W, Efficient, Compact Non-Dimmable CV Class 2 / Class II LED Drivers

### 17 - LABELING

The VLM100W-24 and VLM100E-24-T are used in figure 17 as examples to illustrate typical labels.

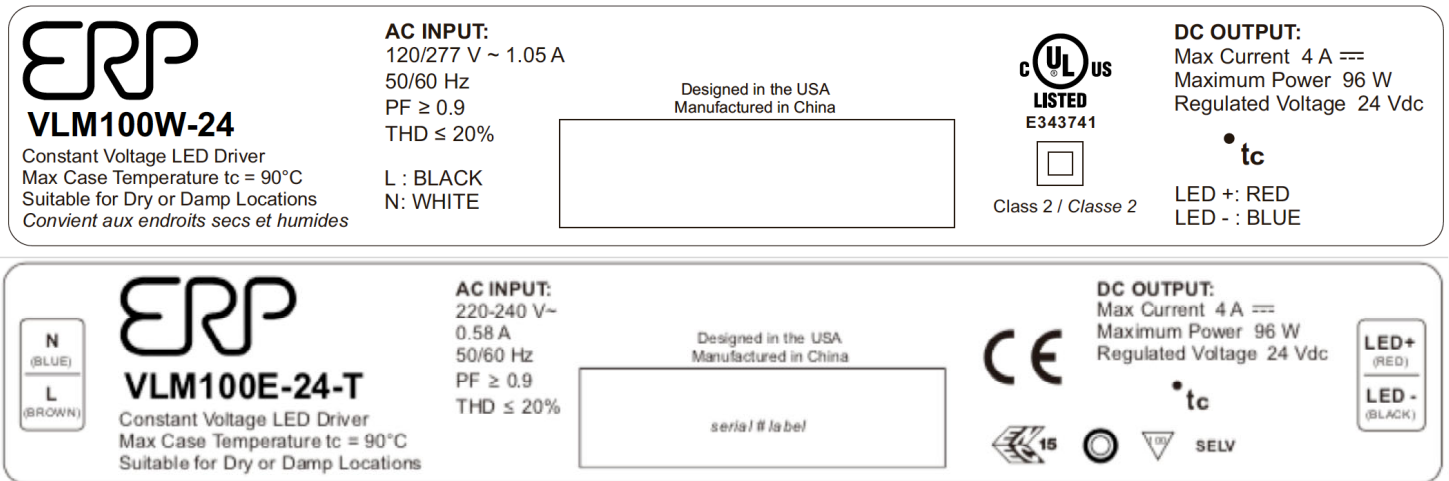

Figure 17

**USA Headquarters**  
Tel: +1-805-517-1300  
Fax: +1-805-517-1411  
893 Patriot Drive, Suite E,  
Moorpark, CA 93021, USA

**CHINA Operations**  
Tel: +86-756-6266298  
Fax: +86-756-6266299  
No. 8 Pingdong Road 2  
Zhuhai, Guangdong, China 519060

ERP Power, LLC (ERP) reserves the right to make changes without further notice to any products herein. ERP makes no warranty, representation or guarantee regarding the suitability of its products for any particular purpose, nor does ERP assume any liability arising out of the application or use of any product or circuit, and specifically disclaims any and all liability, including without limitation special, consequential or incidental damages. "Typical" parameters which may be provided in ERP data sheets and/or specifications can and do vary in different applications and actual performance may vary over time. All operating parameters, including "Typicals" must be validated for each customer application by customer's technical experts. ERP does not convey any license under its patent rights nor the rights of others. ERP products are not designed, intended, or authorized for use as components in systems intended for surgical implant into the body, or other applications intended to support or sustain life, or for any other application in which the failure of the ERP product could create a situation where personal injury or death may occur. Should Buyer purchase or use ERP products for any such unintended or unauthorized application, Buyer shall indemnify and hold ERP and its officers, employees, subsidiaries, affiliates, and distributors harmless against all claims, costs, damages, and expenses, and reasonable attorney fees arising out of, directly or indirectly, any claim of personal injury or death associated with such unintended or unauthorized use, even if such claim alleges that ERP was negligent regarding the design or manufacture of the part. ERP is an Equal Opportunity/Affirmative Action Employer. This literature is subject to all applicable copyright laws and is not for resale in any manner.